

TP-4000 Tree Planter

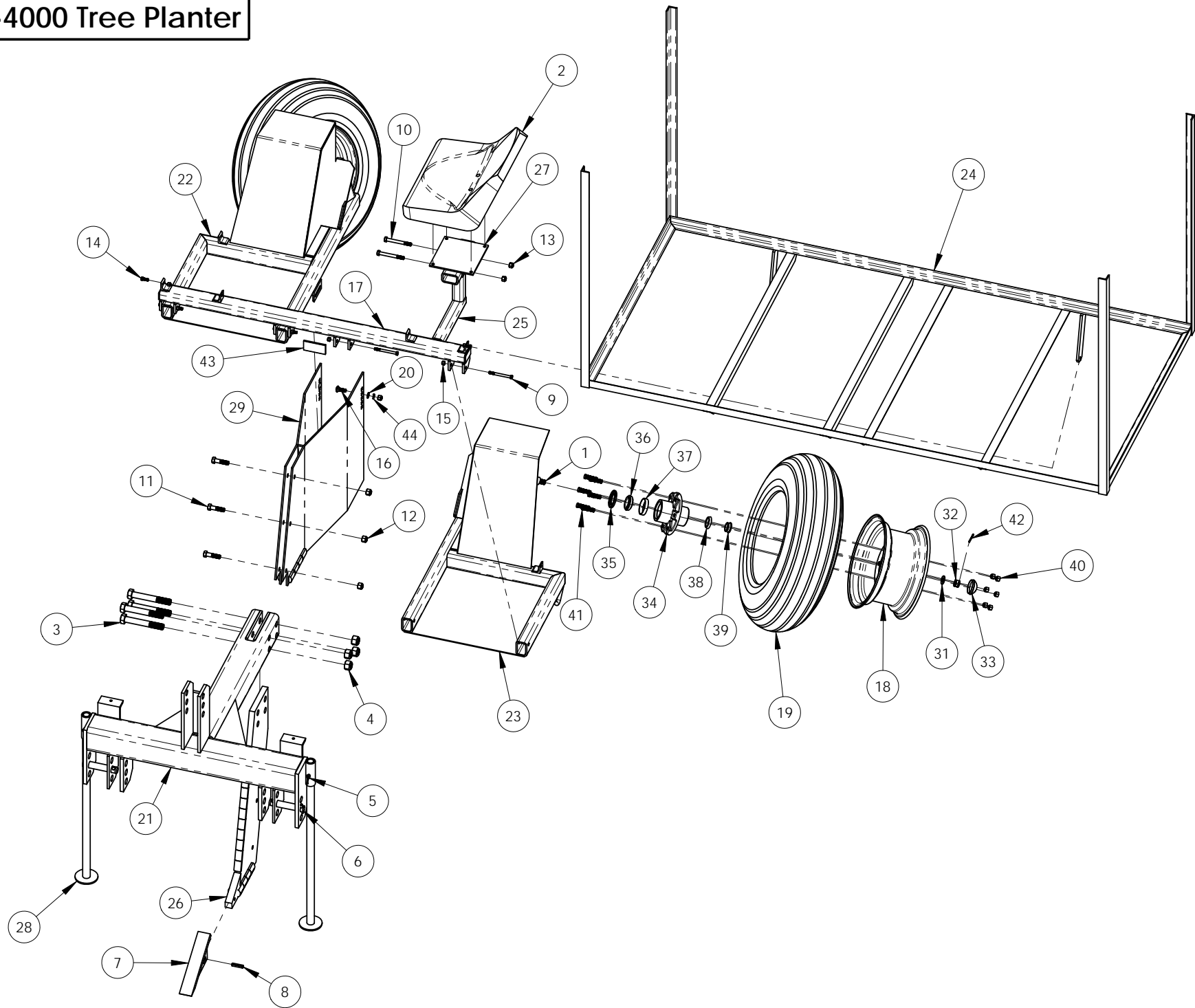

**TREE PLANTER
TP-4000**

ITEM	QTY	PART NO	DESCRIPTION
1	2	RTM-SA3500F	3500 LBS SPINDLE
2	1	1500BK01UN	SEAT
3	4	004-110-3	HHCS 1"-8 GR5, 7"L
4	4	064-016-1	NYLOCK 1"-8 GR5
5	2	P7940	5/16" PTO PIN
6	2	P7235	CAT II Clevis Pin
7	1	14415	HARDFACE POINT
8	1	036-B09-1	1/2" DIA SLOT ROLL PIN
9	4	006-017-1	HHCS 3/8"-16 GR5, 4"L
10	2	007-114-2	HHCS 1/2"-13 GR5, 4-1/2"L
11	3	007-105-1	HHCS 5/8"-11 GR5, 2-1/2"L
12	3	059-407-1	NUT 5/8"-11 GR5
13	4	059-405-1	NUT 1/2"-13 GR5
14	4	006-005-1	HHCS 3/8"-16 GR5, 1"L
15	8	059-403-1	NUT 3/8"-16 GR5
16	2	016-301-1	SQ NECK CARRIAGE BOLT 1/2"-13 GR5, 1-1/2"L
17	1	TP-4006	CROSS BEAM
18	2	W50334	WHEEL 6 BOLT
19	2	11L15	TIRE (Ribbed Implement)
20	2	069-210-1	1/2" Zinc SAE Flat Washer
21	1	TP-3003	3-POINT FRAME
22	1	TP-1001	SIDE FRAME
23	1	TP-1002	SIDE FRAME
24	1	TP-3001	TREE FRAME
25	1	TP-3002	SEAT FRAME
26	1	TP-1009	SHANK
27	1	TP-1010	SEAT BRACKET
28	1	TP-1011	PIPE STAND
29	1	TP-2005	CENTER WELDMENT (OPENER)
30	1	2-35660F-04-00	3500 LBS HUB ASSEMBLY (INCLUDES ALL P/N's WITH *)
31*	2	HR-0382	Spindle Washer 3/4"
32*	2	HR-0381	Spindle Nut 3/4"
33*	2	HR-0375	Grease Cap
34*	2	HR-0082	Wheel Hub w/ bearings & seal (008-423-04)
35*	2	HR-0383	Spindle Seal 2" (010-162-00) (Cross Ref National 473463)
36*	2	HR-0378	Inner Bearing LM501349 (031-075-02)
37*	2	HR-0379	Inner Race LM501310 (031-075-01)
38*	2	HR-0377	Outer Race LM67010 (031-032-02)
39*	2	HR-0376	Outer Bearing LM67048 (031-032-01)
40*	12	HR-0380	9/16" Lug Nut NF (006-060-00)
41*	12	ST562	9/16" NF-2-1/4" Stud (007-280-00)
42*	2	HR-0384	Cotter Pin 1/8" X 2" (019-002-00)
43	1	TP-2012	HR Flat, 1/4" X 2" X 4"L
44	2	072-011-1	1/2" Zinc Lock Washer